

# Installation Instructions

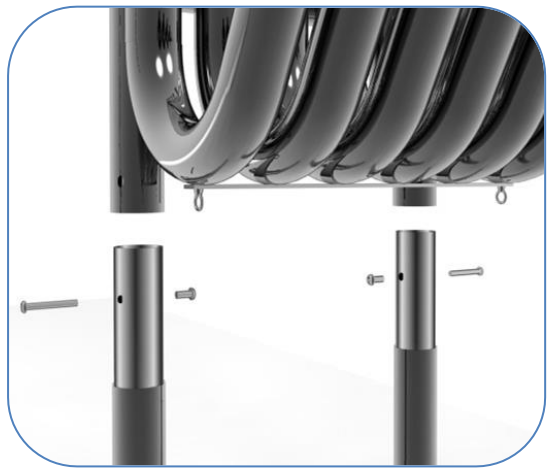

**1. Locate** Tembos frame onto legs and, and bolt into place using pre drilled holes, **2 bolts per post.**(See **Assembly Guide**)

**2. Excavate 1 hole** for Tembos **W300xL900 by 600mm deep** in desired location upon decision from customer. (See **Ground Fix Post Installation sheet**)

**3. Insert the Ground Fix Bar** between the 2 bases of the legs and fix in place with the nuts provided (See **Ground Fix Post Installation sheet**)

**4. Locate frame** into hole according to customers preference. Once happy **fill** holes using rapid hardening **concrete**. Be sure to compact concrete around legs and leave to dry according to manufactures guidelines.



Weight of heaviest part **70kg** (Tembo Frame)

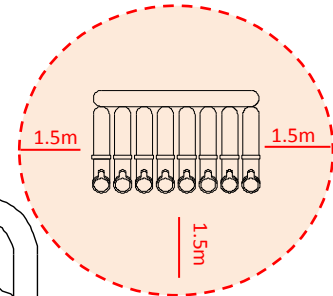

Install Instrument with 1.5m free space (from widest point) around it.

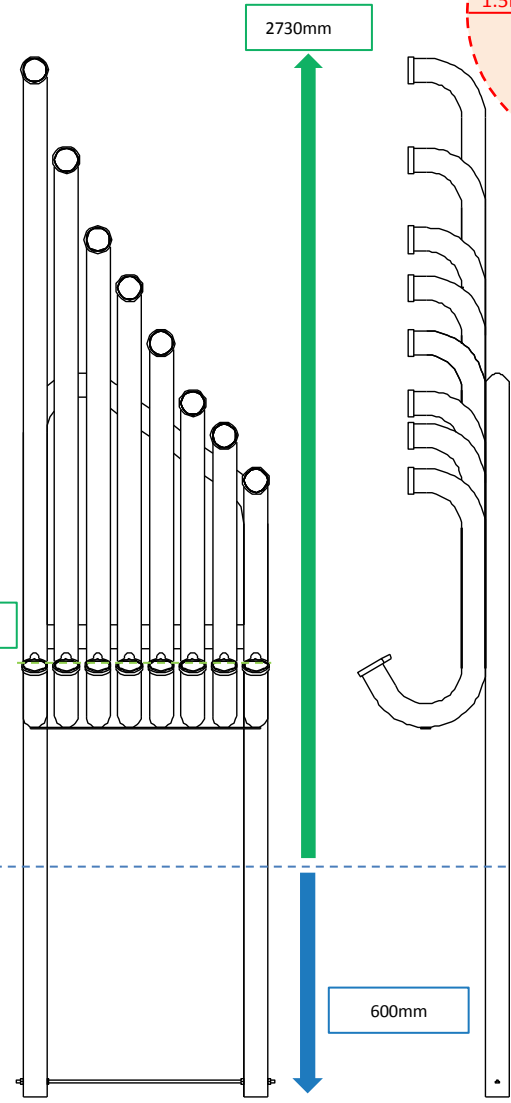

Ground Surface

**CAUTION:** Tembos surface can get hot in direct sunlight, if possible install in shaded areas.

Ground Fixed  
Tembos Diatonic  
Page 1 of 3



Instrument Components:





-  x16
-  x32
-  x2

Metric Conversion:  
300mm/ 12"  
600mm/ 24"  
900mm/ 35"  
1.5m/ 59"  
2730mm/ 107"



Pair Neoprene Paddles X1



Ground Fix Components:

-  x2
-  x2
-  x4
-  x1

Spares available from [percussionplay.com](http://percussionplay.com) or from your local distributor

**80 Kg**

**Tools:**

 x1  
 x2  

Pin Hex Driver Bit      TX 45 Driver Bit

Ground Fixed  
Tembos Diatonic  
Page 2 of 3



Instrument Components:

-  x16
- M10x100 Security Screw
-  x32
- M10 Flanged Slide Bearing
-  x2
- M6 Eye Bolt

Thread Lock Solution  
Required (Not Supplied)



Main Frame will arrive pre assembled

Thread Lock Solution  
Required (Not Supplied)

**CAUTION:** Tembos surface can get hot in direct sunlight, if possible install in shaded areas.

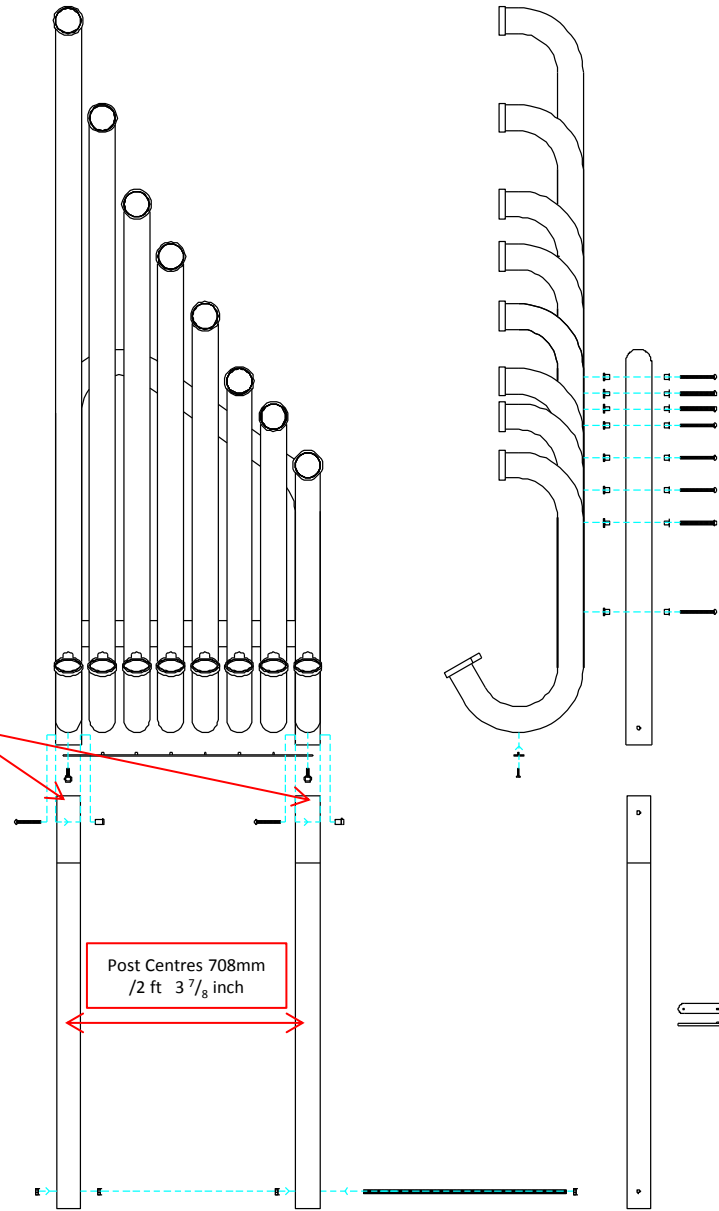





Thread Lock Solution  
Required (Not Supplied)

COMPONENTS LIST:

-  M6 Eye Bolt X2
-  M10x70 Pin torx X4
-  M10 Barrel Nut Pin torx X4
-  M10x100 Pin torx X16
-  M10 Black Slide Plastic Bearing X32
-  SS Brace Bar X1

 Pair Neoprene Paddles X1

Ground Fix Components:

-  x2
-  x2
-  x4
-  x1

Spares available from  
[percussionplay.com](http://percussionplay.com) or from your local distributor

70 Kg

# Ground Fix Post Installation

Foundations should not present a hazard. These foundations are recommended as a guide, for more information on foundation details for various surface see Part 7 of BS EN 1176.

Tools:  
TX 45 Driver Bit x1

Ground Fixed  
Tempos Diatonic  
Page 3 of 3



Components:

-  x2
- M10 Barrel Nut
-  x2
- M10x70 Security Screw
-  x4
- M10 BZP Nut
-  x1
- M10 x 800 Bar

Metric Conversion:  
300mm/ 12"  
600mm/ 24"  
900mm/ 35"

