

# Installation Instructions



Weight of heaviest part **16kg** (Harmony Frame)

**1. Attach Notes to Harmony Frame. (See Assembly Guide Sheet)**

**2. Attach Ground Fixing posts to legs(1.2) (See Ground Fix Post Installation Sheet)**

**3. Excavate 1 hole for the Steel leg 250mm diameter by 400mm deep, in desired location upon decision from customer.**

**4. Locate (lower) legs into hole making sure they are vertical and level prior to concreting in place.**

**5. Once happy with location of the Instrument, fill hole using rapid hardening concrete. Be sure to compact concrete around legs and leave to dry according to manufactures guidelines.**

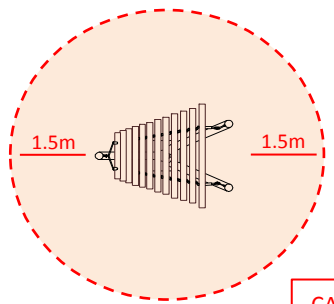

Install Instrument with 1.5m free space (from widest point) around it.

**CAUTION: Harmony surface can get hot in direct sunlight, if possible install in shaded areas.**

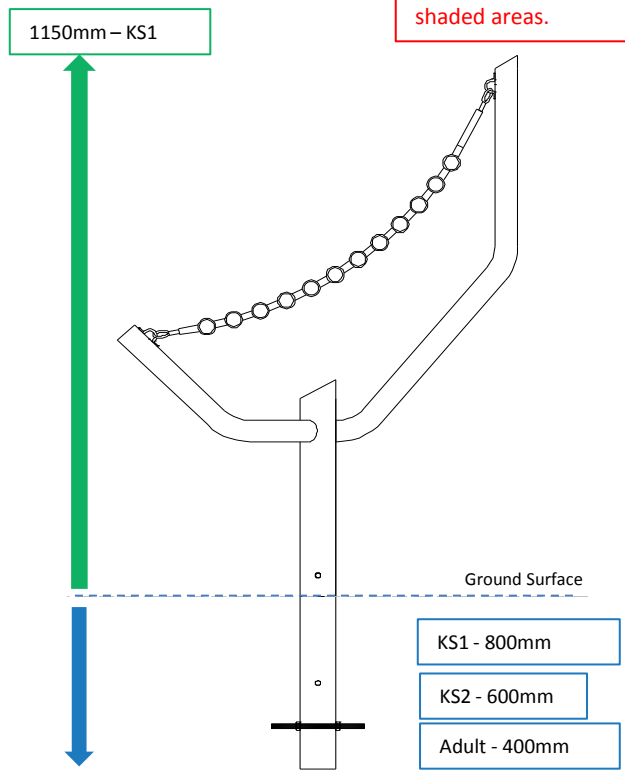

Ground Fixed  
Harmony  
Page 1 of 3



Instrument Components:

- M10 Nut x6
- M6x30 Security Screw x3
- M6 Saddle Strap

Metric Conversion:  
250mm/ 10"  
400mm/ 16"  
600mm/ 24"  
800mm/ 31"  
1150mm/ 45"  
1.5m/ 59"

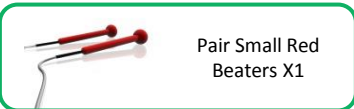

Ground Fix Components:

- M10x200 Bolt x2
- M10 Nut x4
- M10x70 Security Screw x1
- M10 Barrel Nut x1

Spares available from [percussionplay.com](http://percussionplay.com) or from your local distributor

**20 Kg**

# Assembly Guide PPHARM

Ground Fixed  
Harmony  
Page 2 of 3



Instrument Components:

-  x6  
M6x30 Security Screw
-  x3  
M6 Saddle Strap

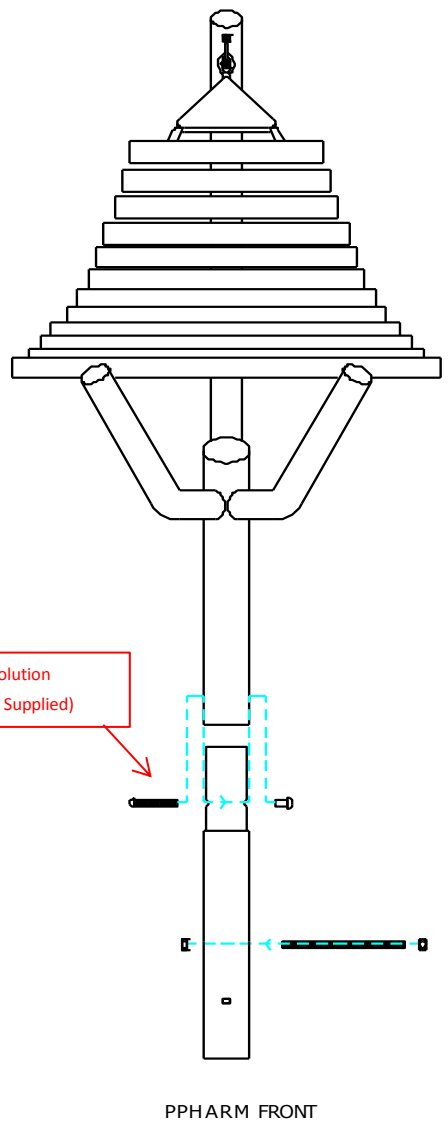

Thread Lock Solution  
Required (Not Supplied)



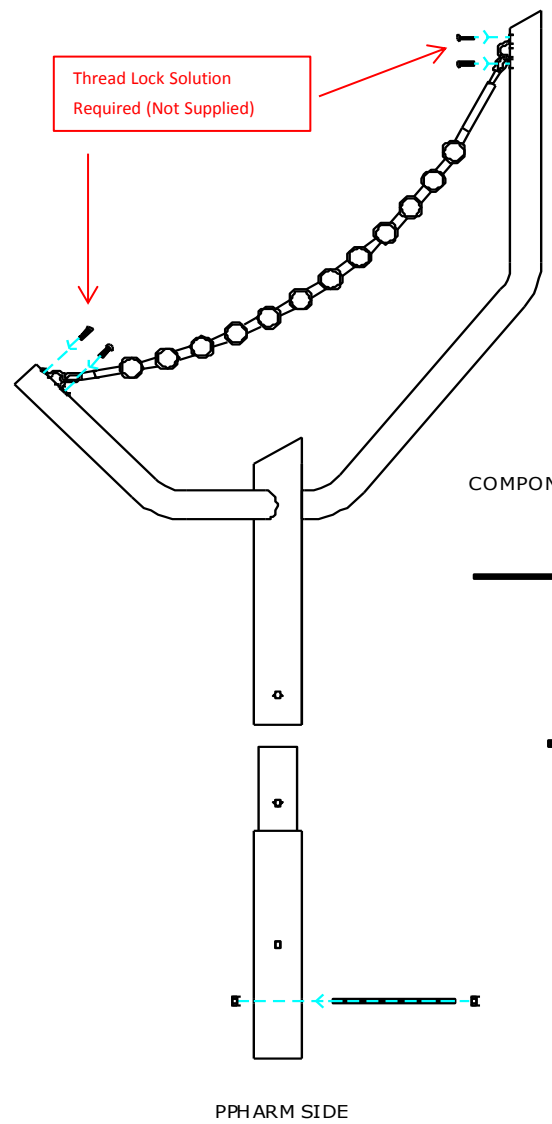





Thread Lock Solution  
Required (Not Supplied)



Thread Lock Solution  
Required (Not Supplied)

- Tools:
-  x1  
TX 30 Driver Bit
  -  x1  
TX 45 Driver Bit

- COMPONENTS LIST:
-  M10 Nut X4
  -  M10x200 Threaded Bar X2
  -  Saddle Strap X3
  -  M6x20 Pin torx X6
  -  M10x70 Pin torx X1
  -  M10 Barrel Nut Pin torx X1

CAUTION: Harmony  
surface can get hot  
in direct sunlight,  
if possible install in  
shaded areas.



Ground Fix Components:

-  x2  
M10x200 Bolt
-  x4  
M10 Nut
-  x1  
M10x70 Security Screw
-  x1  
M10 Barrel Nut

Spares available from  
[percussionplay.com](http://percussionplay.com) or from your  
local distributor

20 Kg

# Ground Fix Post Installation

Ground Fixed  
Harmony  
Page 3 of 3



### Components:

-  x2  
M10x200 Threaded Bar
-  x4  
M10 BZP Nut
-  x1  
M10 Barrel Nut
-  x1  
M10x70 Security Screw

Thread Lock Solution  
Required (Not Supplied)

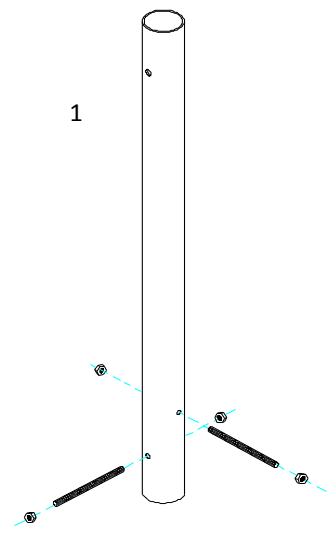

1  
Insert M10x 150 Threaded bar into pre drilled holes in Ground Fixing Post

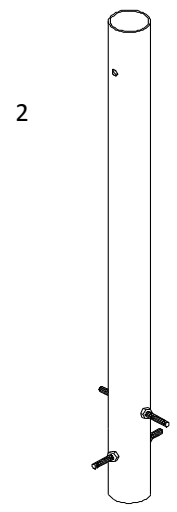

2  
Fix M10x 150 Threaded bar in place using M10 Nuts

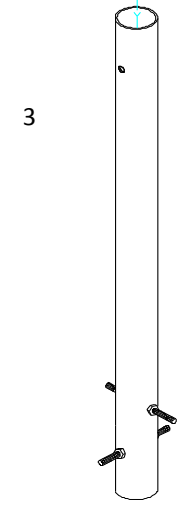

3  
Locate the Ground fix Post into the leg of the instrument.

Thread Lock Solution  
Required (Not Supplied)

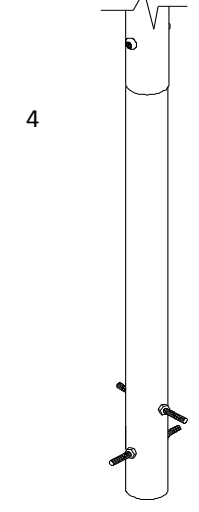

4  
Fix instrument to Ground fix post using M10 bolt and Barrel Nut and use **thread locking solution** to prevent fixings working loose.

Foundations should not present a hazard. These foundations are recommended as a guide, for more information on foundation details for various surface see Part 7 of BS EN 1176.

- Tools:
-  x1  
TX 45 Driver Bit

Metric Conversion:  
50mm/ 2"  
250mm/ 10"  
350mm/ 14"  
400mm/ 16"  
450mm/ 18"

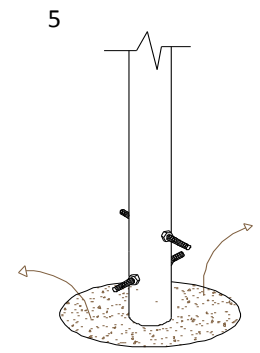

5  
Excavate 6 holes with a 250mm diameter tapering down to 350mm diameter and 450mm depth

**400mm min depth**

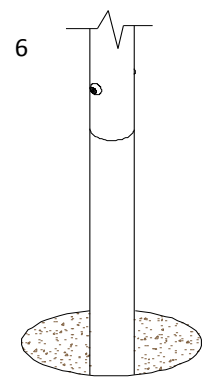

6  
Compact base of hole with 50mm of aggregate. Lower ground Fix post attached to instrument into hole (check instrument straight and level before filling with concrete)

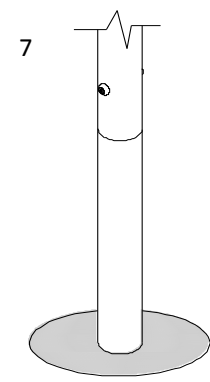

7  
Fix hole with fast drying concrete to manufacturers specifications.

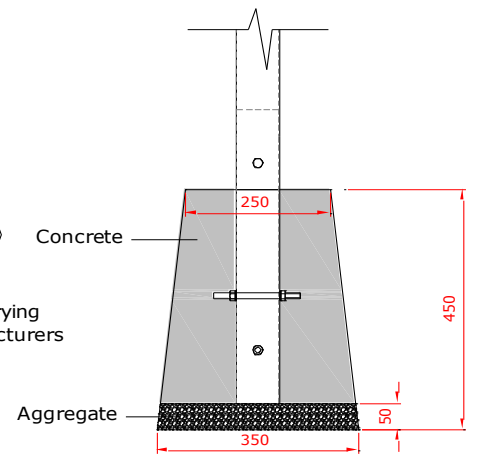

Concrete

Aggregate